

VON DUPRIN®



Auxiliary Hardware & General Information

Exit Devices

Contents

Introduction	2	Cylinders & Latches	12
Pushing Forward	3	Glass Bead Kit – GBK	12
About Von Duprin	4	RG-27 Vertical Rod & Latch Guard	12
ANSI Functions for Exit Hardware	5	237 & 237L Two Point Latch	13
Sex Bolts	6	Handing – How to Order	13
Vertical Rods	7	Mullions	14
Rim, Mortise & Concealed Vertical Rod	7	Steel Mullions	15
Surface Vertical Rod	8	Aluminum Mullions	15
Cover Plates	10	Sizes for Mullions	15
229 Kit	10	Weatherstripping	16
882 Kit	10		
997 Kit	10		
887 Kit	10		
589 Kit	10		
888 Kit	10		
889 Kit	11		
998 Kit	11		
#10 WDA Kit	11		
33A WDA Kit	11		
Dog Keys	11		

Symbols



Indicates fire rated application

Customer Service

US: 877-671-7011, Option 1
CAN: 800-900-4734
Support@Allegion.com

Technical Support

877-671-7011, Option 2
Exits_TechProdSupport@Allegion.com
YouTube.com/VonDuprinSafety

Ordering

Allegion_Orders@Allegion.com
eFax: 800-999-0328

PUSHING FORWARD™

Over a century ago, Von Duprin invented the first self-releasing fire exit device. Today we continue to push the envelope by delivering innovative solutions to challenging applications. Our durable panic and exit door hardware products are proven to perform and are backed by a team of experts. We provide flexible solutions and modular options to protect your investment well into the future.



Quality

Von Duprin leads the industry with durable solutions that are proven in the field to perform under heavy use and abuse and backed by a team of experts experienced in door hardware application and code compliance.



Flexibility

Von Duprin empowers you to embrace change by providing flexible solutions that can be modified over time as new trim, functions or other options are required, protecting your investment well into the future.



Trust

Von Duprin designed the first self-releasing fire exit device more than a century ago and continues to advance fire and life safety, with innovation and best-in-class support to address your most challenging applications with code compliant solutions.

ABOUT VON DUPRIN

As the pioneer in the industry, Von Duprin continues to advance the industry through customer-centric innovation, which delivers solutions to the most challenging applications.

Backed by high quality standards, Von Duprin exit devices were among the first in the industry certified to ANSI/BHMA A156.3 (2014) Grade 1. Our exit devices are tested to the highest standards and proven in the field to perform under heavy use and abuse, giving you peace of mind both now and in the future.

The versatile design can be easily upgraded to connect to a larger electronic ecosystem, empowering you to adapt with flexible solutions. You can configure numerous variations in the field without replacing your device and protecting your investment. This makes upgrades easy and cost effective.

Flexible Solutions for Real-World Applications

Our brand's reputation, respect and legacy stem from that first exit device in 1908—and they continue because of the quality of Von Duprin® products we've produced since. Today, Von Duprin remains the trusted name in the industry by engineering products that meet the highest industry standards for fire and life safety. It's this dedication to providing customers with dependable products that ensures you can put your trust in the Von Duprin brand.

Passion Driving Performance

Von Duprin's exit devices offer durable solutions that are proven in the field to perform under heavy use and abuse and backed by a team of experts experienced in door hardware application and code compliance. Allegion stands behind every Von Duprin product we make with unparalleled customer support thanks to our team of experts based in the U.S. that average more than 15 years of experience, so you are assured to receive expert advice.

ANSI Functions for Exit Hardware

ANSI Functions for Exit Hardware

A variety of ANSI functions are offered with each series. Each device section of the catalog contains a chart showing the ANSI types and functions available in the series.

Function	
01	Exit only, no trim
02	Entrance by trim when actuating bar is locked down
03	Entrance by trim when latch bolt is retracted by key. Key removable only when locked
04	Entrance by trim when latch bolt is retracted by key or set in a retracted position by key
05	Entrance by thumbpiece. Key locks or unlocks thumbpiece
06	Entrance by thumbpiece only when released by key. Key removable only when locked
07	Entrance by thumbpiece. Inside key locks or unlocks thumbpiece. Outside key retracts latch
08	Entrance by knob or lever. Key locks or unlocks knob
09	Entrance by knob or lever only when released by key. Key removable only when locked
10	Entrance by knob or lever. Inside key locks or unlocks knob. Outside key retracts latch
11	Entrance by control turn piece. Key locks or unlocks control
12	Entrance by control turn piece only released by turning key. Key removable only when locked

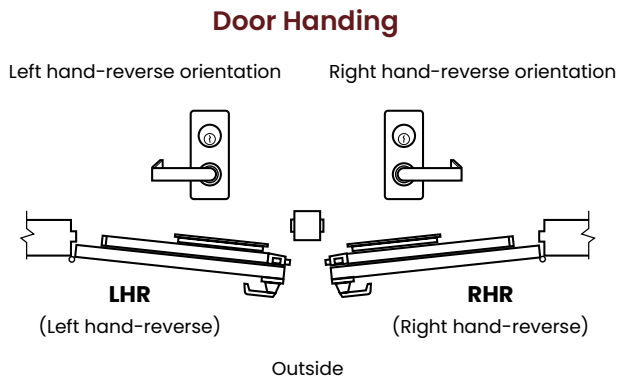

Sex Bolts

Sex Bolts when ordered with devices may be furnished with screw lengths different than shown in Column B. On pages 7 and 8, Column B indicates popular sizes. Sex bolts ordered separately aren't furnished with screws. If screws are required, refer to [chart on pages 7 and 8](#) and order screws by description as a separate item. Other screw lengths may be used based on minimum and maximum allowable thread engagement, shown in column "C." Quantity required—refer to device section, quantities differ depending on outside trim.

425 sex bolts are required for 22/88/98/99 series fire rated devices when used on wood door applications. When wood doors are specified for these devices, sex bolts will be added to the device application unless SLM blocking package is specified.

825 sex bolts are required with 98-F/99-F rim devices on wood door applications using EO, NL, TP, K and L outside trims. Two 825 sex bolts will be added to the device application unless SLM blocking package is specified.

To Order, Specify

1. Model number
2. Quantity (2 per package)
3. Finish
4. Door thickness other than 1-3/4" (44mm)

325



425



525



625A



625B



825

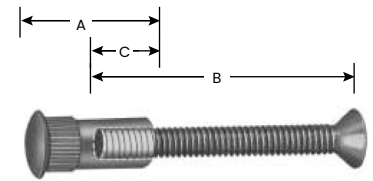

325, 425, 625A & 625B

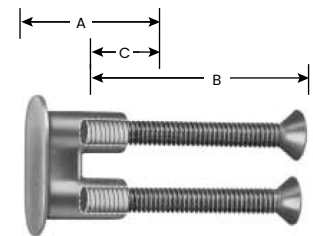

Refer to [pages 7 and 8](#) for A, B, and C lengths.

Vertical Rods

Rim, Mortise & Concealed Vertical Rod

Device Type	Door Thickness	Center Case				Hinge Case			
		Sex Bolt		B Screw	C Thread Engagement Min.-Max.	Sex Bolt		B Screw	C Thread Engagement Min.-Max.
		No.	A			No.	A		
22	1-3/4" (44mm)	425	1-9/16"	10-24 x 1" PPHMS	9/32"-5/8"	425	1-9/16"	10-24 x 3/4" PPHMS	9/32"-5/8"
	2-1/4" (57mm)	425 w	1-9/16"	10-24 x 1-1/2" PPHMS	9/32"-5/8"	425	1-9/16"	10-24 x 1-1/4" PPHMS	9/32"-5/8"
33A, 3347A, 3347A-F, 35A, 3547A, 3547A-F	1-3/4" (44mm)	325	1-9/32"	1/4-20 x 1" FPHMS	3/8"-11/16"	425	1-9/16"	10-24 x 3/4" PPHMS	9/32"-5/8"
	2-1/4" (57mm)	325	1-9/32"	1/4-20 x 1-1/2" FPHMS	3/8"-11/16"	425	1-9/16"	10-24 x 1-1/4" PPHMS	9/32"-5/8"
55	1-3/4" (44mm)	625A	2-5/16"	12-24 x 3/4" OPHMS	11/32"-13/16"	625A	2-5/16"	12-24 x 3/4" OPHMS	9/32"-13/16"
	2-1/4" (57mm)	625B	2-13/16"	12-24 x 3/4" OPHMS	11/32"-1"	625B	2-13/16"	12-24 x 1-1/4" OPHMS	11/32"-1"
5575, 5575-F, 5547, 5547-F	1-3/4" (44mm)	—	—	—	—	625A	2-5/16"	12-24 x 3/4" OPHMS	11/32"-13/16"
	2-1/4" (57mm)	—	—	—	—	625B	2-13/16"	12-24 x 1-1/4" OPHMS	11/32"-1"
88, 88-F, 8875, 8875-F	1-3/4" (44mm)	425	1-9/16"	10-24 x 1-1/2" OPHMS	9/32"-5/8"	425	1-9/16"	10-24 x 1-1/2" OPHMS	9/32"-5/8"
	2-1/4" (57mm)	425	1-9/16"	10-24 x 2" OPHMS	9/32"-5/8"	425	1-9/16"	10-24 x 2" OPHMS	9/32"-5/8"
8847-F	1-3/4" (44mm)	—	—	—	—	425	1-9/16"	10-24 x 1-1/2" OPHMS	9/32"-5/8"
	2-1/4" (57mm)	—	—	—	—	425	1-9/16"	10-24 x 2" OPHMS	9/32"-5/8"
98, 9875, 9875-F, 9847, 9847-F, 99, 9975, 9975-F, 9947, 9947-F	1-3/4" (44mm)	425	1-9/16"	10-24 x 1" PPHMS	9/32"-5/8"	425	1-9/16"	10-24 x 1" PPHMS	9/32"-5/8"
	2-1/4" (57mm)	425	1-9/16"	10-24 x 1-1/2" PPHMS	9/32"-5/8"	425	1-9/16"	10-24 x 1-1/2" PPHMS	9/32"-5/8"
98-F, 99-F*	1-3/4" (44mm)	425 825A*	1-9/16"	10-24 x 1" PPHMS	9/32"-5/8"	425	1-9/16"	10-24 x 3/4" PPHMS	9/32"-5/8"
			1-13/16"	10-24 x 3/4" PPHMS	9/32"-5/8"				
	2-1/4" (57mm)	425 825B*	1-9/16"	10-24 x 1-1/2" PPHMS	9/32"-5/8"	425	1-9/16"	10-24 x 1-1/4" PPHMS	9/32"-5/8"
			1-13/16"	10-24 x 3/4" PPHMS	9/32"-5/8"				

FPHMS – Flat Phillips head machine screw

OPHMS – Oval Phillips head machine screw

PPHMS – Pan Phillips head machine screw

UFPHMS – Undercut flat Phillips head machine screw

Vertical Rods

Surface Vertical Rod

Device Type	Door Thickness	Center Case			Hinge Case			Top & Bottom Latch Case					
		Sex Bolt No.	A	B Screw	C Thread Engagement Min.-Max.	Sex Bolt No.	A	B Screw	C Thread Engagement Min.-Max.	Sex Bolt No.	A	B Screw	C Thread Engagement Min.-Max.
2227, 2227-F	1-3/4" (44mm)	425	1-9/16"	10-24 x 1" PPHMS	9/32"-5/8"	425	1-9/16"	10-24 x 3/4" PPHMS	9/32"-5/8"	325	1-9/32"	1/4-20 x 3/4" UFPHMS	3/8"-11/16"
	2-1/4" (57mm)	425	1-9/16"	10-24 x 1 1/2" PPHMS	9/32"-5/8"	425	1-9/16"	10-24 x 1-1/4" PPHMS	9/32"-5/8"	325	1-9/32"	1/4-20 x 1-1/4" UFPHMS	3/8"-11/16"
3327A 3527A	1-3/4" (44mm)	325	1-9/32"	1/4-20 x 1" FPHMS	3/8"-11/16"	425	1-9/16"	10-24 x 3/4" PPHMS	9/32"-5/8"	325	1-9/32"	1/4-20 x 3/4" UFPHMS	3/8"-11/16"
	2-1/4" (57mm)	325	1-9/32"	1/4-20 x 1 1/2" FPHMS	3/8"-11/16"	425	1-9/16"	10-24 x 1-1/4" PPHMS	9/32"-5/8"	325	1-9/32"	1/4-20 x 1-1/4" UFPHMS	3/8"-11/16"
8827, 8827-F	1-3/4" (44mm)	425	1-9/16"	10-24 x 1 1/2" OPHMS	9/32"-5/8"	425	1-9/16"	10-24 x 1-1/2" OPHMS	9/32"-5/8"	425	1-9/32"	10-24 x 3/4" PPHMS	9/32"-5/8"
	2-1/4" (57mm)	425	1-9/16"	10-24 x 2" OPHMS	9/32"-5/8"	425	1-9/16"	10-24 x 2" OPHMS	9/32"-5/8"	425	1-9/32"	10-24 x 1-1/4" PPHMS	9/32"-5/8"
9827, 9827-F 9857, 9857-F	1-3/4" (44mm)	425	1-9/16"	10-24 x 1" PPHMS	9/32"-5/8"	425	1-9/16"	10-24 x 3/4" PPHMS	9/32"-5/8"	325	1-9/32"	1/4-20 x 3/4" UFPHMS	3/8"-11/16"
	2-1/4" (57mm)	425	1-9/16"	10-24 x 1 1/2" PPHMS	9/32"-5/8"	425	1-9/16"	10-24 x 1-1/4" PPHMS	9/32"-5/8"	325	1-9/32"	1/4-20 x 1-1/4" UFPHMS	3/8"-11/16"

FPHMS – Flat Phillips head machine screw
OPHMS – Oval Phillips head machine screw
PPHMS – Pan Phillips head machine screw
UFPHMS – Undercut flat Phillips head machine screw

Vertical Rods

This page left intentionally blank.

Cover Plates

229 Kit

(For 22 Rim Device)

Kit contains inside and outside plates for hinge stile cutouts, an inside plate for the lock stile, and necessary screws. Plates are designed to cover cutouts required by most existing exit device installations. Specify finish.

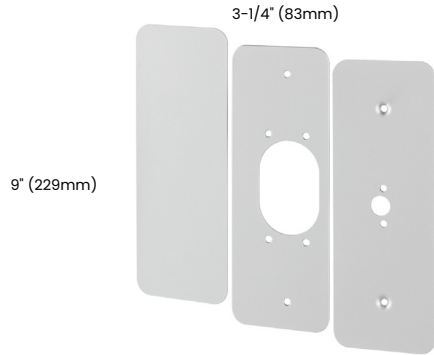

887 Kit

(For 88 Rim/8827 Devices)

For use with rim/vertical device combinations on pairs of doors with ANSI cut-out. The 88 rim device backset is increased and exposes the 161 cutout when used with an 8827. Specify finish.

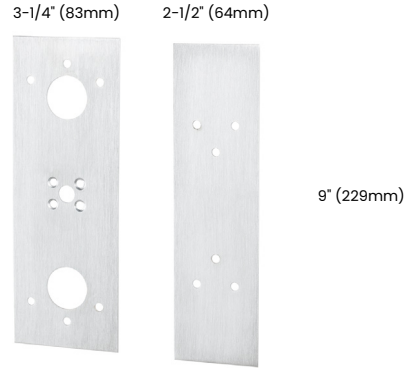

882 Kit

(For 88 Rim Device)

For use to cover mortise lock or discontinued device cut-outs. Specify finish.

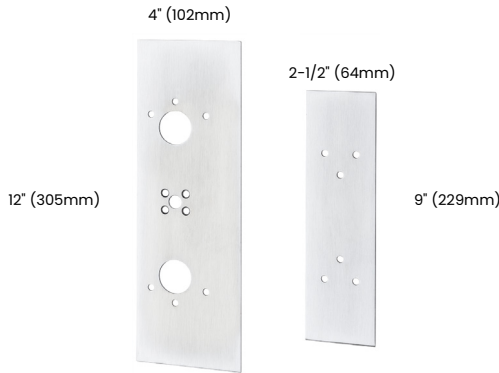

589 Kit

(For 5575 Device)

Kit contains plates for the lock stile and hinge side of the device, and necessary screws. Plates are designed to mount to device on wood door applications. The mortise lock cut-out interferes with device mounting. Specify finish and door width other than 1-3/4 inches (44mm).



997 Kit

(For 98/99 Rim Device)

Kit contains inside and outside plates for hinge stile cutouts, an inside plate for lock stile, and necessary screws. Plates are designed to cover cutouts required by most existing exit device installations. Specify finish.

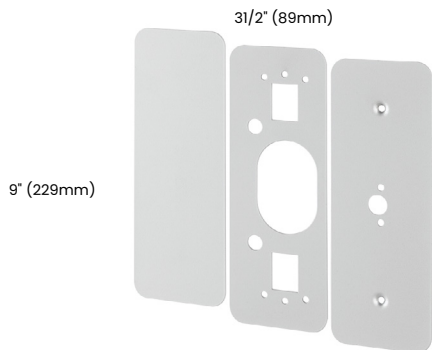

888 Kit

(For 8875 or 8827 Devices)

For use on doors with ANSI 161 cutouts. Device center case will not cover stock cutout. Specify finish.

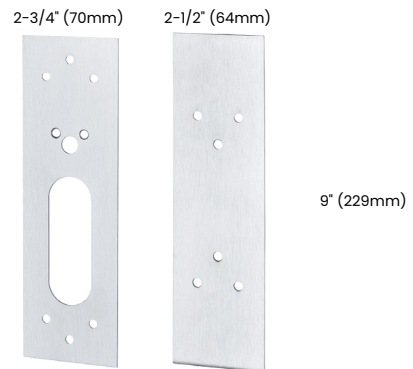

Cover Plates

889 Kit

(For 373L Control)

Required when 373L controls are used with sex bolts. Four studs on cover plate allow through bolting to the device center case. **Note:** Sex bolts must be used on wood or composite fire doors. Specify device type R, M, or V and finish.

998 Kit

(For 994L Trim)

For use with 994 lever trim to cover existing 992 lever trim cut-out. Specify finish.

#10 WDA Kit

(For 370 Series Controls)

For wood door applications, used to cover up door preparations for control, also prevents the control from boring into the wood door. Finished to match control.

33A WDA Kit

(For 360 Series Controls)

For wood door applications to cover up door preparations for control, also prevents the control from boring into the wood door. Finished to match control.

Dog Keys

222 Dog Key (Old Style)

5/32" (4mm) hex

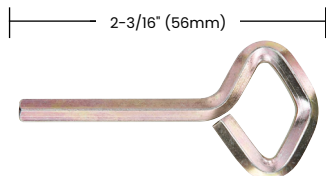

227 Dog Key (Standard)

5/32" (4mm) hex

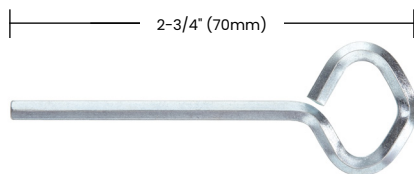

889 Kit

3" (76mm)



11" (279mm)

#10 WDA Kit

2" (51mm)

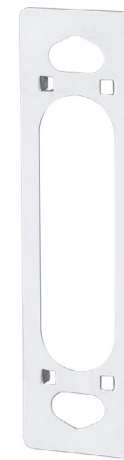

7-7/8" (200mm)

33A WDA Kit

2" (51mm)

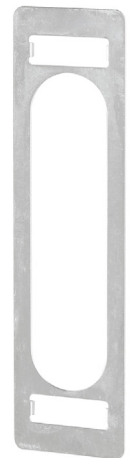

7-7/8" (200mm)

Cylinders & Latches

Cylinders are not furnished with device or trim and must be specified when ordering. Refer to exit device catalogs for cylinder requirements.



Mortise – 3215 (Schlage 20-001, L583-477 cam)

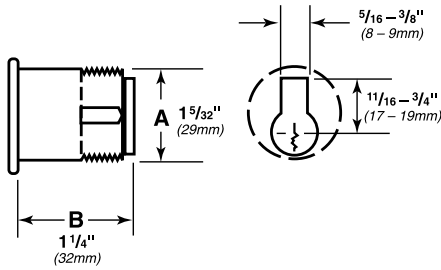

Rim – 3216 (Schlage 20-022)

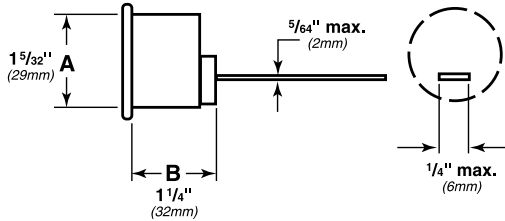

Glass Bead Kit – GBK

Glass bead conversion kits are used on doors with glass beads. Each kit consists of $\frac{1}{4}''$ (6 mm) shim sets. GBK for surface vertical rod ships with $\frac{1}{8}''$ (3 mm) shims for rod guides.

To Order, Specify:

1. Device model, example: 99GBK
2. Device type (rim, mortise, surface vertical rod, concealed vertical rod)
3. Wood door, when used with concealed vertical rod
4. Specify if using with 499F strike
5. Finish

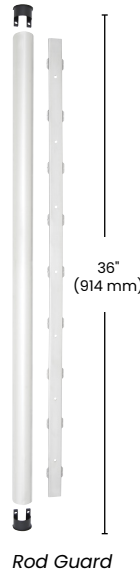

RG-27 Vertical Rod & Latch Guard

RG-27 Series vertical rod and latch guards protect the bottom rods of exit devices from the damaging impacts of carts or gurneys passing through doors. (If bottom rods become damaged, the exit device will not function as intended and can jeopardize the ability to exit safely during an emergency.)

In addition to protecting the vertical rod, the guard provides a smooth, unobstructed surface so the door can be pushed open easily with the bumpers of a wheelchair. The latch guard portion is 10" high. The standard latch guard features a 45° ramp. The extended latch guard offers a continuous ramp in 3' or 4' widths.

All stainless steel construction in US32D finish. Latch guards can cover latches as large as $1\frac{1}{4}''$ W x 10" H x $1\frac{7}{8}''$ projection.

Latch Guard

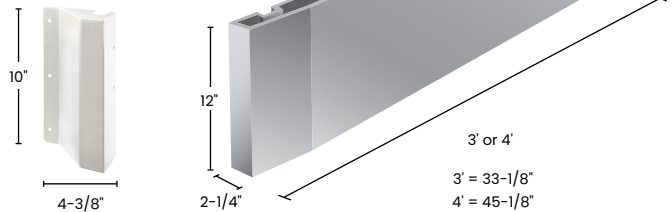

Models

RGO	Rod guard only (Projection 1-3/16")
RG-27	Rod and latch guard
RG-27-3	3' (914 mm) Rod guard and extended latch guard
RG-27-4	4' (1219 mm) Rod guard and extended latch guard
LGO	Latch guard only
LGO-3	3' (914 mm) Extended latch guard only
LGO-4	4' (1219 mm) Extended latch guard only

Note: Not for use on wood fire doors, except with SLM (special laminate material) blocking.

To Order, Specify:

1. Model number
2. Handing (except on RGO)
3. Door material if other than hollow metal
4. Optional sex bolt mounting available

237 & 237L Two Point Latch



Series 237 two point latch assembly is ideal for spaces where occupancy does not require panic or fire exit hardware. This product is a perfect solution for many applications in schools, health care facilities, offices, and government facilities—regardless if the doors are inswing or outswing. It can be used on the inactive leaf of a pair of doors with a lockset or both leaves of a pair. It features a top soffit latch and ratchet release for long service life and dependability. Locking handles in many different configurations provide versatility to meet different customer needs.

Engineered to withstand severe weather conditions, the 237 series is also ideal for community shelters and safe rooms in accordance with FEMA 320 and 361 guidelines.

Specifications Compliance

- I. UL listings:
 - Two- and Three-point Locks and Latches (for use on Fire Doors)—UL 10 C
 - Rating: 3HR pairs (double egress)
 - 90 min. pairs (swing same direction)
 - Door size: 8'0" X 8'0" Pairs (hollow metal only)

Furnished standard with one lever control assembly with mounting plate for the push side. This lever operation is always unlocked (L-BE). A second control lever can be ordered separately for the pull side, either model 378L-BE (always unlocked) or model 378L (with cylinder locking). Cylinders not included.

Lever operation meets all ADA requirements.

Plunger Release Bracket Soffit Latch Assembly

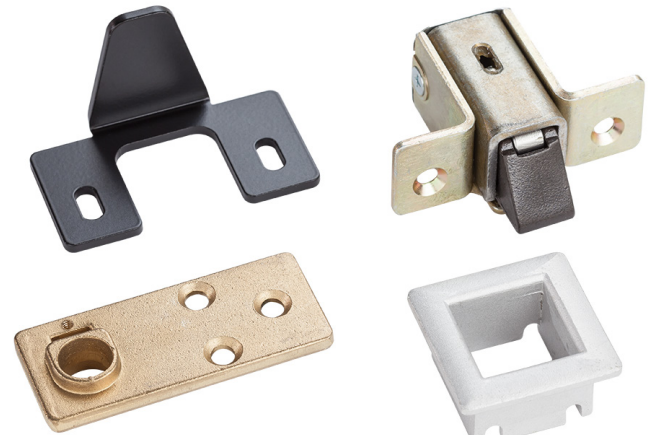

Bottom Bolt Guide

304L Strike

To Order, Specify:

1. Model number 237L-BE
2. Optional second control, 378L or 378L-BE
3. Handing (see charts below)
4. Finish

Optional lever styles are available



Handing – How to Order

Outswing Door Application

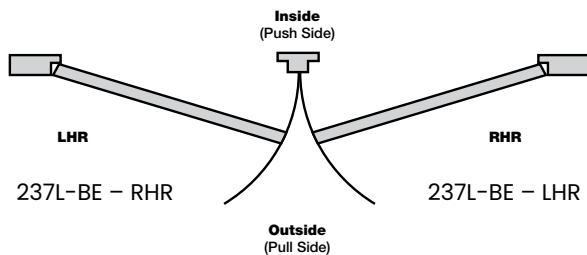

Push Side

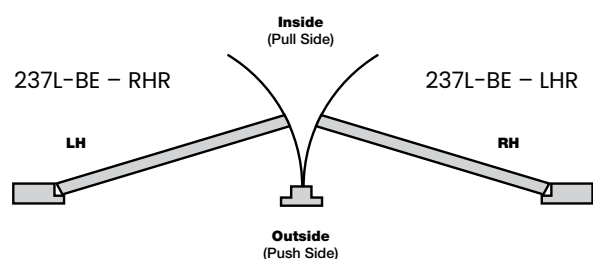

Note: For inswing door applications that require locking on the push side, consult factory. Outswing door will be assumed if not specified.

Mullions

Removable steel mullions Mullions provide single door performance in double door openings with rim devices. Mullions are easily removed by loosening bottom set screw and removing top fitting cover. The top mullion fitting is attached to the frame and is concealed by the fitting cover.

Steel mullions are 2" (51mm) wide and 3" (76mm) deep, with a wall thickness of 1/8" (3mm).

Mullions are shipped with mounting screws and prepared for strikes. Strikes are not included except where indicated.

Steel mullions are available in SP28 and SP313 finishes. Consult factory for other powder coat finish options.

KR – Keyed removable steel mullions makes removal faster and easier by a single operation of the mortise cylinder. Once mullion is removed, large equipment or furniture can freely pass through the opening. The unit will self lock when re-installed, without use of the cylinder key. Uses a 1-1/4" mortise cylinder with a straight cam (Schlage cam reference B502-191). Cylinders are sold separately. Prefix mullion model with "KR".

Removable aluminum mullions are 1-1/16" (27mm) wide on face closest to the door and 2-3/8" (60mm) at the widest point. The depth is 3-1/8" (79mm) with a wall thickness of 1/8" (3mm).

Aluminum mullions are available in US4, US10, US28, 313 and 315 finishes. Consult factory for other powder coat finish options.

Stock hollow metal applications for devices mounted to cover ANSI 161 cutouts are higher than the standard mullion strike location. Consult the factory for special strike preparation or order a blank mullion. See below.

Blank mullions are furnished without strike preparation. They are used to mount devices at a strike height different from the standard mullion preparation.

To Order, Specify:

1. For keyed removable option on steel mullions, prefix model number with "KR"
2. Model number
3. Height of opening
4. Finish
5. Handing if required
6. Centerline deviation (refer to device template for standard centerline)
7. Strikes, when required, should be ordered with device
8. For keyed Removable option on steel mullions, prefix model number with "KR"

Removable Mullions

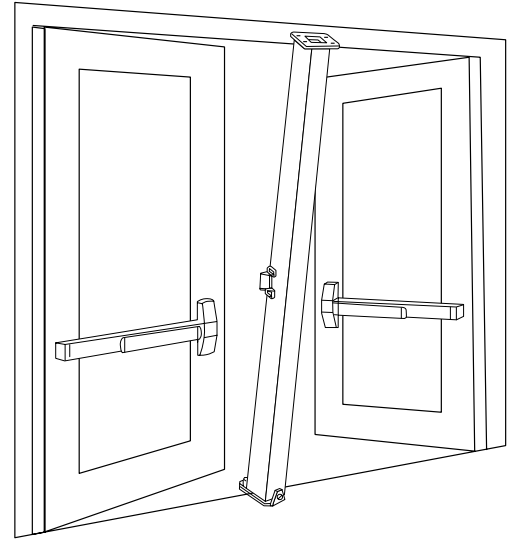

Keyed Removable Steel Mullions

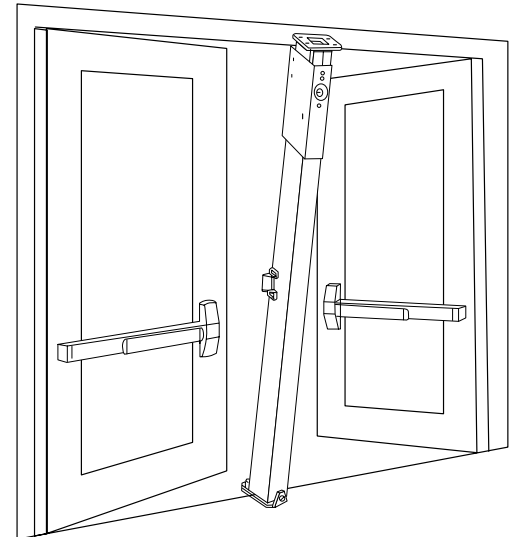

Mullions

Steel Mullions

1654 Prepared for two 1606 strikes. If 1606 strikes are not specified on the order, two per mullion will be added. Additional charges apply.

4954 Prepared for 264 or 299 strikes. For use with all Von Duprin Panic rim devices. Note: Specify strike choice with device.

9954 Prepared for and must be used with two 268 strikes (88-F device), or two 499F (22-F, 98-F, 99F devices). UL fire labeled mullion for up to 3 hour opening using Von Duprin fire exit rim devices. This mullion is not easily removed due to special fittings.

22-F and 88-F devices are rated up to 8' x 8" (2438mm x 2438mm).

98-F and 99-F devices are rated up to 10'0" (3048mm).

Note: If 268 or 499F strikes are not specified on the order, two per mullion will be added. Additional charges apply.

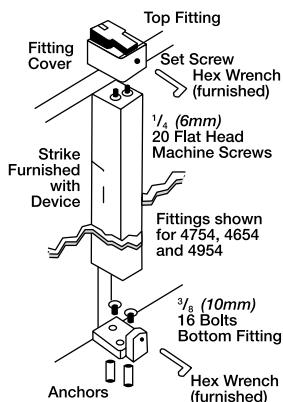
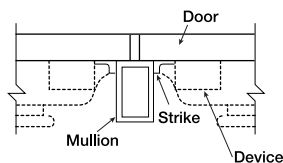

4754 Prepared for two 4263 monitor strikes.

4854 Prepared for one 299 and one 6111 electric strike. Indicate handing for electric strike.

9854 Prepared for one 268 or 499F strike and one 6111 electric strike. Indicate handing for electric strike. UL fire labelled mullion for up to 3 hour openings up to 8' x 8' (2438mm x 2438mm) using Von Duprin fire exit rim devices.

Aluminum Mullions

4854/9854 – Using one electric strike

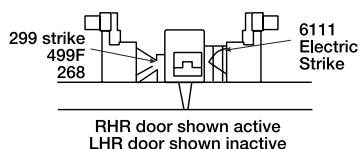

5654 Prepared for two 264 or 299 strikes with weatherstripping. Includes one set of 154 stabilizers.

5754 Prepared and furnished with one 1408 double door strike. Includes one 154 stabilizer set. Note: specify device "less strike".

Sizes for Mullions

1654, 4954, 4754, 4854, 5654

7' 2" (2184mm)
8' 2" (2489mm)*
10' 2" (3099mm)*

9854, 9954

7' 3" (2210mm)
8' 3" (2475mm)
10' 3" (3124mm)

KR1654, KR4954, KR4754, KR4854

7' 6" (2286mm)
8' 6" (2591mm)
10' 6" (3200mm)

KR9854**

KR9954***

7' 5" (2261mm)
8' 5" (2565mm)*
10' 5" (3175mm)*

* Only qualifying applications will be provided with UL Label.

** Fire rated same as 9854

*** Fire rated same as 9954

Angle plate is used with narrow transom frames. The plate attaches to the transom extending the surface area needed to mount the mullion. Must be ordered separately. Specify finish.



154 Stabilizer is a two-piece interlocking set. One piece mounts on the mullion with the top mounting hole 5-3/16" (148mm) below the centerline of the strike; the other piece mounts on the door. Shims are provided to adjust for misalignment between the door and mullion.

The set maintains integrity between the door and mullion to prevent vandalism and to ensure contact between the device and strike as the doors expand and contract with temperature changes.

Furnished standard on aluminum mullions; optional for steel and all blank steel mullions.



MT54 Storage kit is a set of floor and wall brackets that provide convenient storage of the keyed removable mullion when removed from the opening.

To Order, Specify

1. Model MT54
2. Finish SP28, SP313, or SPBLK

Weatherstripping

Weatherstripping prevents cold air from blowing between doors and mullion. It also serves as a silencer when the door is closed against the mullion. The silicone treated weatherstrip pile is bonded to a polypropylene backing. A slide-in molding houses the weatherstripping, covers mounting screws of the strike and extends to both the top and bottom of the mullion. Available on aluminum mullions only.

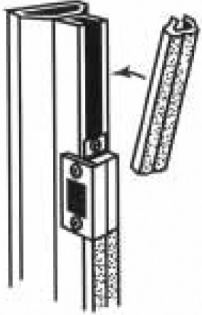

Edging with Weatherstripping

About Allegion

At Allegion (NYSE: ALLE), we design and manufacture innovative security and access solutions that help keep people safe where they live, learn, work and connect. We're pioneering safety with our strong legacy of brands like CISA®, Interflex®, LCN®, Schlage®, SimonsVoss® and Von Duprin®. Our comprehensive portfolio of hardware, software and electronic solutions is sold around the world and spans residential and commercial locks, door closer and exit devices, steel doors and frames, access control and workforce productivity systems.

For more, visit www.allegion.com

KRYPTONITE ■ LCN ■  ■ STEELCRAFT ■ VON DUPRIN